

Thick film thermal printhead (with thermal historical control)

KD3003-DC70A

DC70 series has our own internally developed heat-history control function.

This product is best suited for applications which require 24 hours operation like factory production lines.

●Applications

- High speed label printer
- High speed bar code printer
- High speed ticket printer
- Various high speed terminal printers

●Features

- 1) Newly developed thick-film fast response thermal element and driver LSI with the function of thermal history control which is added the future history control are employed for this series. It is possible to print with super high speed of 10 inches / s or 250 mm / s.
- 2) 150km life realized by attributing durable new protection film.
- 3) New partial glaze construction makes it compatible with the thermal transfer application.

●External dimensions (Unit : mm)

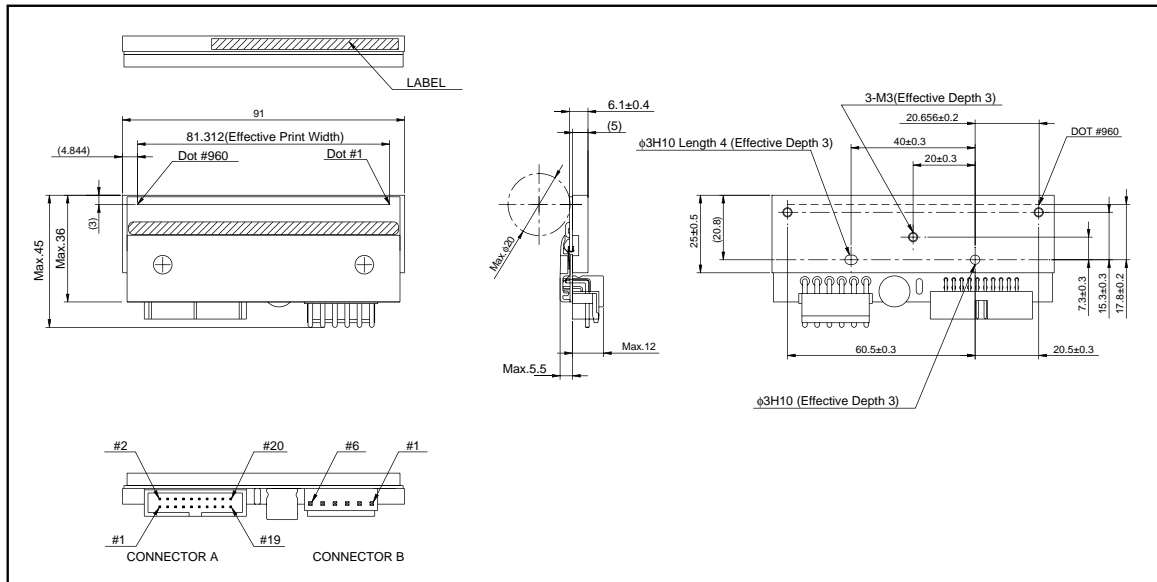

Printhead

●Equivalent circuit

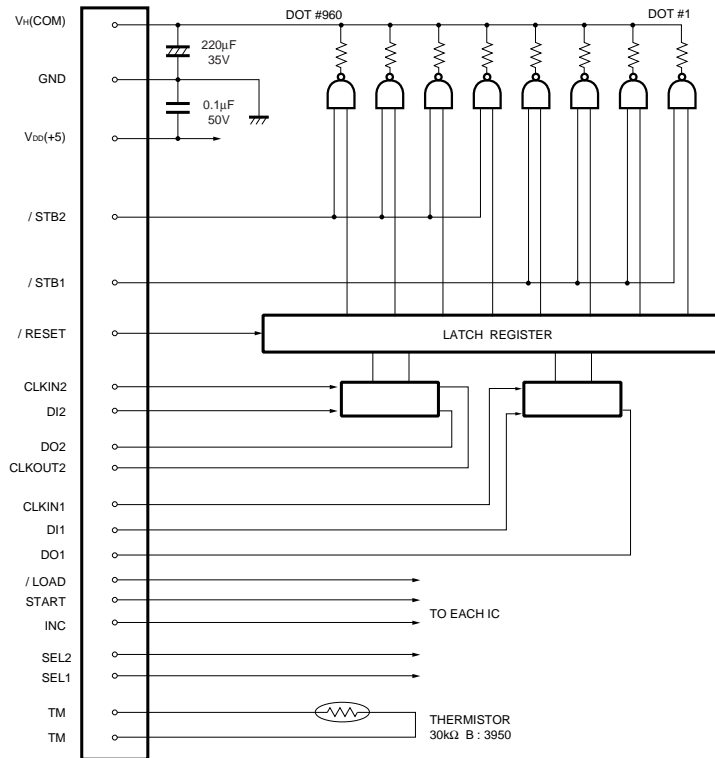

DI No.	DOT No.	/ STB No.	DOT No.	CLK No.	DOT No.
DI2	960~513	/ STB2	960~513	CLKIN2	960~513
DI1	512~ 1	/ STB1	512~ 1	CLKIN1	512~ 1

Fig.1

●Pin assignments

CONNECTOR A	
No.	Circuit
1	V _{DD}
2	V _{DD}
3	SEL2
4	SEL1
5	CLKIN2 (CP)
6	NC
7	DI2
8	DI1
9	INC
10	/LOAD
11	/RESET
12	START
13	DO1
14	DO2
15	TM
16	TM
17	/STB2
18	/STB1
19	CLKOUT2
20	CLKIN1

CONNECTOR B	
No.	Circuit
1	V _H (COM)
2	V _H (COM)
3	V _H (COM)
4	GND
5	GND
6	GND

Printhead

●Characteristics

Parameter	Symbol	Typical	Unit
Effective printing width	–	81.312	mm
Dot pitch	–	0.0847	mm
Total dot number	–	960	dots
Average resistance value	Rave	1000	Ω
Applied voltage	V _H	24	V
Applied power	P _o	0.53	W/dot
Print cycle	SLT	0.41	ms
Maximum number of dots energized simultaneously	–	960	dots
Maximum clock frequency	–	8	MHz
Maximum roller diameter	–	φ20.0	mm
Running life / pulse life	–	150/(1×10 ⁸)	km/pulses
Operating temperature	–	5 to 45	°C

●Data sheets

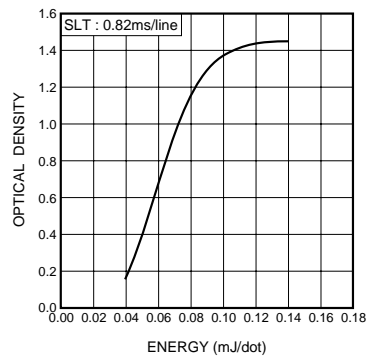

Fig.2 Representative density curve

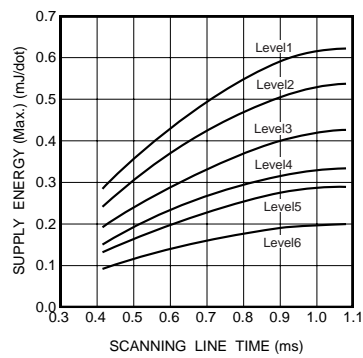

Fig.3 Maximum energy curve

Notes

- No technical content pages of this document may be reproduced in any form or transmitted by any means without prior permission of ROHM CO.,LTD.
- The contents described herein are subject to change without notice. The specifications for the product described in this document are for reference only. Upon actual use, therefore, please request that specifications to be separately delivered.
- Application circuit diagrams and circuit constants contained herein are shown as examples of standard use and operation. Please pay careful attention to the peripheral conditions when designing circuits and deciding upon circuit constants in the set.
- Any data, including, but not limited to application circuit diagrams information, described herein are intended only as illustrations of such devices and not as the specifications for such devices. ROHM CO.,LTD. disclaims any warranty that any use of such devices shall be free from infringement of any third party's intellectual property rights or other proprietary rights, and further, assumes no liability of whatsoever nature in the event of any such infringement, or arising from or connected with or related to the use of such devices.
- Upon the sale of any such devices, other than for buyer's right to use such devices itself, resell or otherwise dispose of the same, no express or implied right or license to practice or commercially exploit any intellectual property rights or other proprietary rights owned or controlled by
- ROHM CO., LTD. is granted to any such buyer.
- Products listed in this document are no antiradiation design.

The products listed in this document are designed to be used with ordinary electronic equipment or devices (such as audio visual equipment, office-automation equipment, communications devices, electrical appliances and electronic toys).

Should you intend to use these products with equipment or devices which require an extremely high level of reliability and the malfunction of which would directly endanger human life (such as medical instruments, transportation equipment, aerospace machinery, nuclear-reactor controllers, fuel controllers and other safety devices), please be sure to consult with our sales representative in advance.

About Export Control Order in Japan

Products described herein are the objects of controlled goods in Annex 1 (Item 16) of Export Trade Control Order in Japan.

In case of export from Japan, please confirm if it applies to "objective" criteria or an "informed" (by MITI clause) on the basis of "catch all controls for Non-Proliferation of Weapons of Mass Destruction.